

# DELIVERY SPECIFICATIONS

Textile wall 3x3

## Layout

### Document size:

#### 3x3 front

2250 x 2250 mm (WxH)

#### 3x3 front + side

2830 x 2250 mm (WxH)

### Layout size

Provide 3 mm bleed all around on which you let the image continue. This way you will avoid any visible white edge on your textile wall.

### Delivery specification:

Between 72 and 125 DPI

CMYK color profile: Europe ISO Coated FOGRA39

Submit as Certified PDF with cutting marks and 3 mm bleed all around.

## Layout template

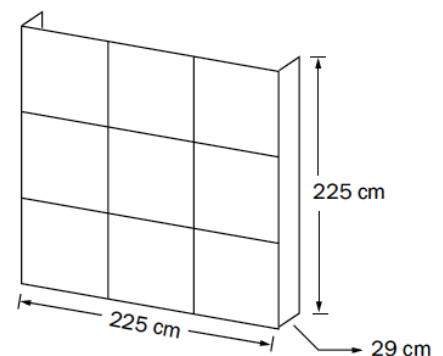
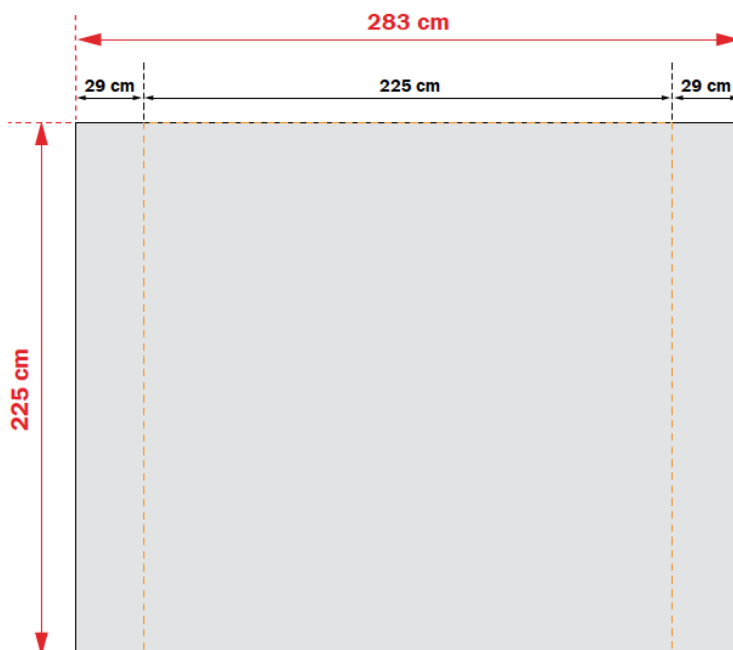

If you have any questions or comments, please feel free to contact us.